

# **VLF Hipot Tester**

**Huazheng Electric Manufacturing (Baoding) Co., Ltd**

## Contents

I. VLF HV Tester Series.....	2
II. Important Tips.....	2
III. Product Brief.....	4
IV. Technical Parameters.....	4
V. Description Of Instrument Structure.....	5
VI. Operation Instruction.....	7
VII. Accompanied Accessories.....	14
VIII. Packing List.....	14

**I. VLF HV Tester Series**

Model no	Rated Voltage	Load Carrying Capacity	Power FuseTube	Product Structure
HZDP-30	30kV (Peak)	0.1Hz, ≤1.1μF	10A	Controller Booster
		0.05Hz, ≤2.2μF		
		0.02Hz, ≤5.5μF		
HZDP-40	40kV (Peak)	0.1Hz, ≤1.1μF	10A	Controller Booster
		0.05Hz, ≤2.2μF		
		0.02Hz, ≤5.5μF		
HZDP-50	50kV (Peak)	0.1Hz, ≤1.1μF	20A	Controller Booster
		0.05Hz, ≤2.2μF		
		0.02Hz, ≤5.5μF		
HZDP-60	60kV (Peak)	0.1Hz, ≤1.1μF	20A	Controller Booster
		0.05Hz, ≤2.2μF		
		0.02Hz, ≤5.5μF		
HZDP-80	80kV (Peak)	0.1Hz, ≤1.1μF	20A	Controller Booster
		0.05Hz, ≤2.2μF		
		0.02Hz, ≤5.5μF		
HZDP-90	90kV (Peak)	0.1Hz, ≤1.1μF	20A	Controller Booster
		0.05Hz, ≤2.2μF		
		0.02Hz, ≤5.5μF		

Select products of appropriate specifications according to the subjects

When in use, the capacitance of the test object shall not exceed the rated capacitance of the instrument. If the capacitance of the test object is too small, the output waveform will be affected. If it is less than 0.05 μ F, the instrument will not output normally. At this time, 0.05 μ f capacitor (provided by the company) can be connected in parallel for auxiliary output. See Table 4 and table 5 for the estimation of capacitance of common electrical equipment.

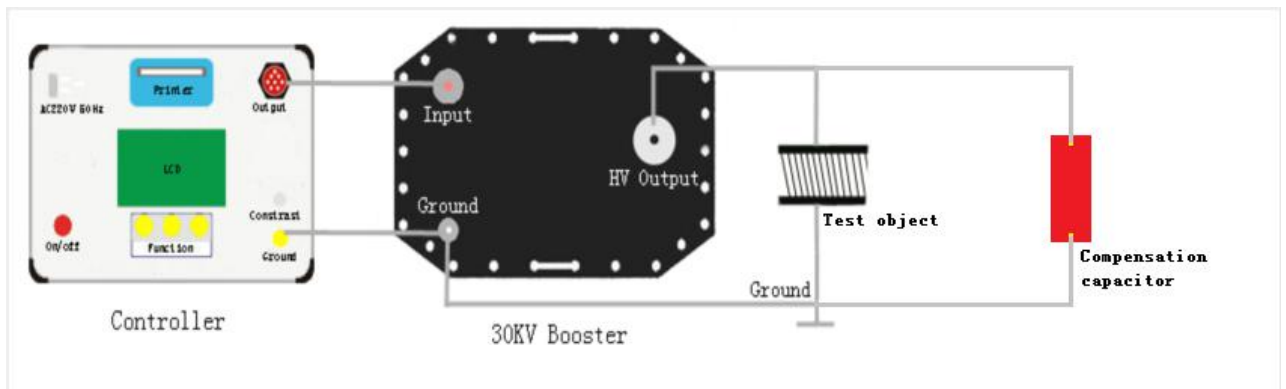

Table 4 single phase earth capacity of different types of generators.

	Steam turbine generator				Hydro generator		
Capacity (MW)	200	300	600	85	125-150	300	400
Single phase ground capacitance(uF)	0.198	0.18-0.26	0.31-0.34	0.69	1.8-1.9	1.7-2.5	2.0-2.5

Table 5 capacitance of XLPE insulated single core power cable (μ f / km)

capacitance (uf/Km)	Cross-sectional area (mm)	16	25	35	50	70	95	120	150	185	240
		Voltage(KV)									
10		0.15	0.17	0.18	0.19	0.21	0.24	0.26	0.28	0.32	0.38
35		—	—	—	0.11	0.12	0.13	0.14	0.15	0.16	0.17

Estimation method of test object current:

Calculation formula:  $I = 2 \pi F C U$

## II. Important Tips

1. Power supply requirement: AC50Hz, 220V, stability of frequency: fluctuation less than 0.5%
2. When using it, the capacitance of the sample should not exceed the rated capacity of

the instrument. The overflow capacitance of the sample will affect the output wave form. If the capacitance is less than  $0.05\mu\text{F}$ , the instrument cannot output normally.

3. When using it, it is prohibited to boost voltage without load, or to connect with resistive load.

### III. Product Brief

The product combines modern advanced digital variable frequency technology and micro computer control together, therefore, it can realize the full automatic voltage boost, stepdown, measurement and protection as well as the manual intervention in the process of automatic voltage boost. The full electronic design ensures the small size and light weight. The big LCD screen ensures the clear and visual display, and can display the output wave form. The printer outputs test reports. In addition, the product has features as follows:

- ★ Data of current, voltage, wave form can be directly sampled at high voltage side, so the data is real and accurate.
- ★ Overvoltage protection: If the output exceeds the set limit of voltage, the instrument will shut-down to protect itself, the actuation time is less than 20ms.
- ★ Overcurrent protection: it is high-low voltage dual protection in the design, the accurate shut-down protection can be made according to the set value at high voltage side; If the current on low voltage side exceeds the rated current, the instrument will take shut-down protection, the actuation time are both less than 20ms.
- ★ A high voltage output protective resistor is provided in the voltage boost body in the design and this eliminates the need of additional protective resistor connected outside.

### IV. Technical Parameters

1. Output voltage ratings: See Details of Table 1
2. Output frequency: 0.1Hz, 0.05Hz, 0.02Hz
3. Measurement accuracy: 3%
4. Positive and negative voltage peak errors:  $\leq 3\%$
5. Voltage wave form distortion:  $\leq 5\%$
6. Use condition: indoor and outdoor; temperature:  $-10^{\circ}\text{C} \sim +40^{\circ}\text{C}$

Humidity:  $\leq 85\%RH$

7. Power: AC50Hz, 220V  $\pm 5\%$

8. Power supply fuse tube: See Details of Table 1

## V. Description Of Instrument Structure

### 1. Controller Panel Schematic

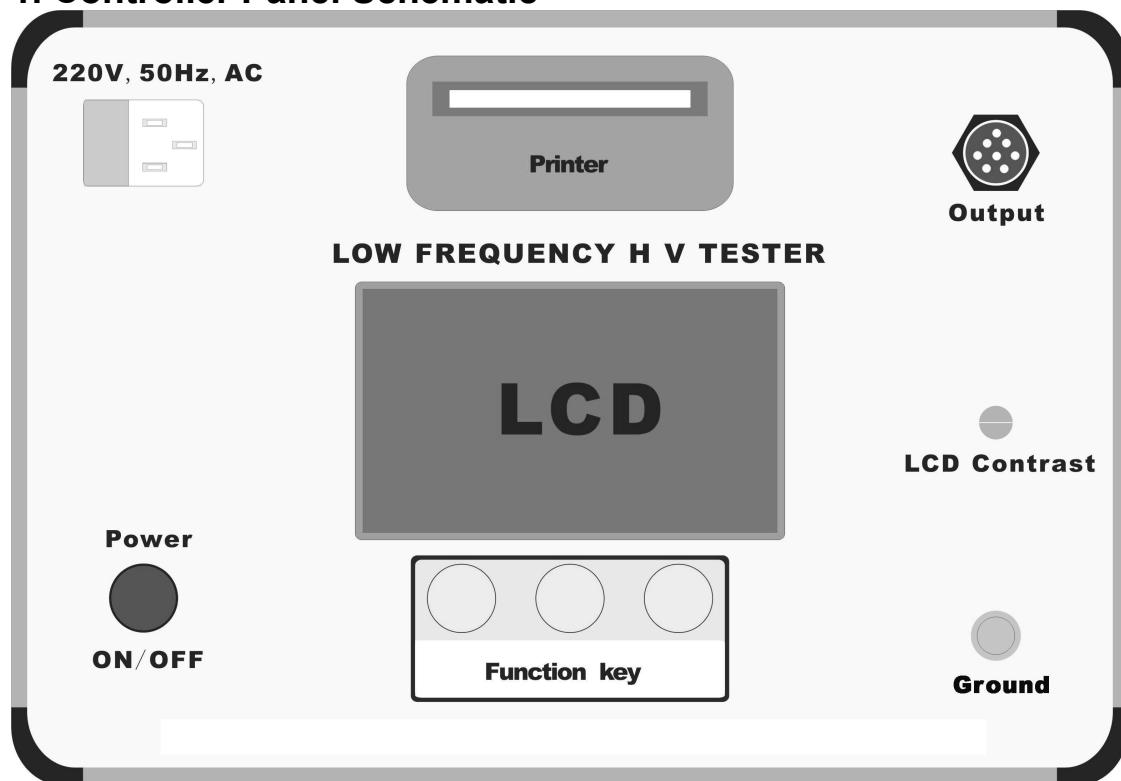

**Figure 1**

Schematic of parts and function description in figure 1:

- (1) "Ground": Grounding terminal, which is connected with ground when being used.
- (2) "Output": The output multi-core socket, which is connected with the input multi-core socket when being used.
- (3) "Contrast": The contrast adjusting knob, which is used for the adjustment of contrast of the LCD.
- (4) "Function key": The function is prompted at corresponding location at prompt column on the display.
- (5) "AC 220V": The power input socket with inbuilt fuse tube.

- (6) "Switch": power switch with inbuilt indicator light, which illuminates upon open and extinguishes upon close.
- (7) "Printer": print the test report
- (8) "LCD": It displays test data and output wave form.

**2. Schematic Of Booster Structure**

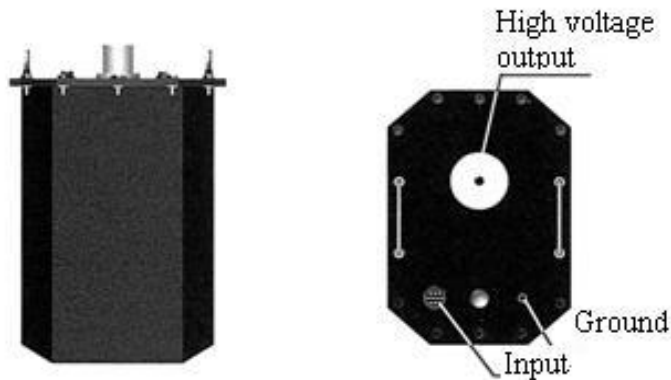

Figure 2

**3. Schematic And Description Of The Display**

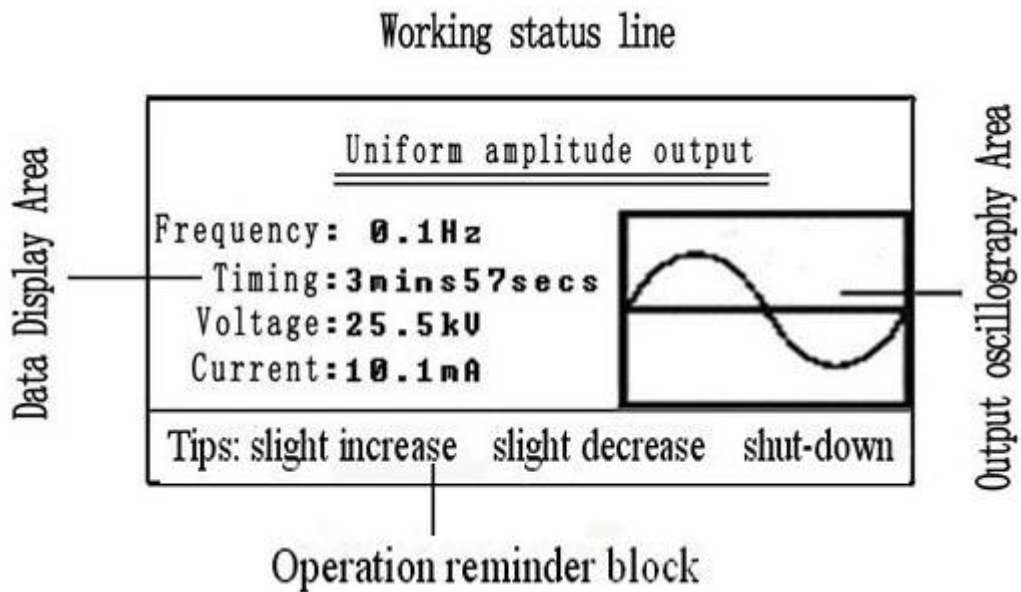

Figure 3

## VI. Operation Instruction

### (1)、Wiring Method of booster

The method of wiring shall be according to figure 1

Setting after the equipment is power on (as shown in figure below).

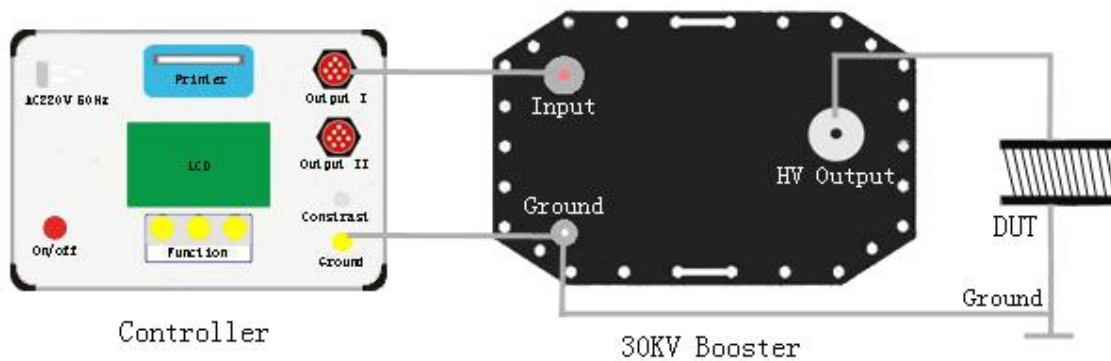

Figure 4-1-1 (30-90kV Wiring drawing)

### (3).Schematic of Cable wiring method

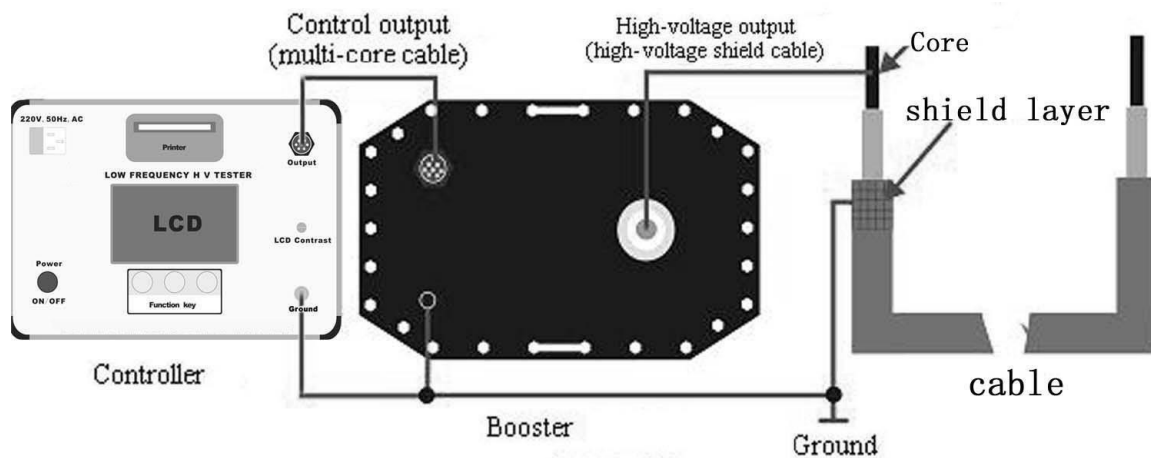

Figure 4-3 (Schematic of Cable wiring method)

### (4). Schematic of Generator connection method

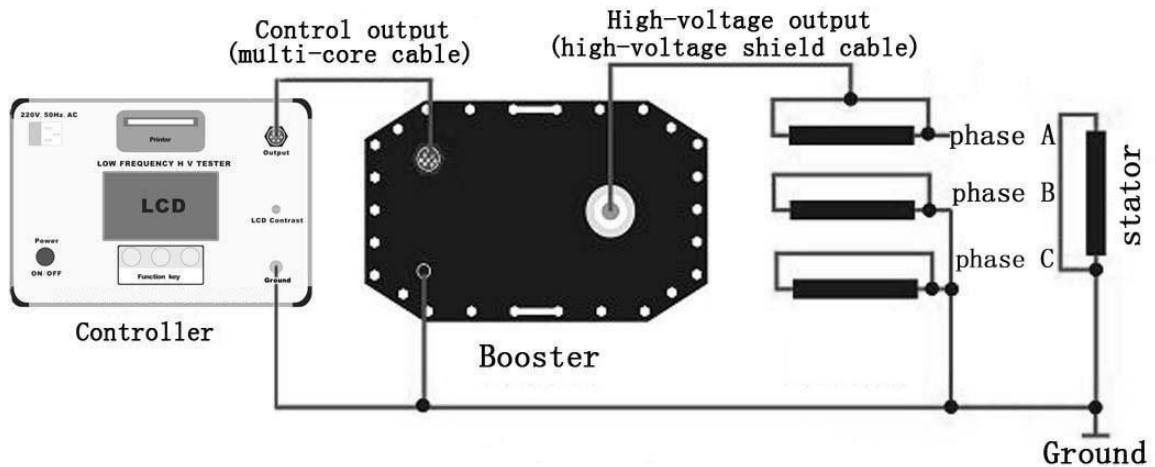

Figure 4-4 (Schematic of Generator connection method)

## 2. Operation Procedure

### (1) Open, close and reset

After completing the wiring of all the circuits in the method motioned above, the power switch can be put on. The instrument will automatically enter into the limit setting interface as shown in figure 5 when the microcomputer is electrified and reset. The power shall be shut-down on wiring, removal of lines or temporary non-use of the instrument. The power socket is provided with fuse tube, in case there is no display on the screen upon start-up, the first check shall be made on the fuse tube. The rating of the replaced tube shall be according to the data in Table 1.

### (2) Limit parameter setting

<u>Parameter setting</u>		
Frequency:	<b>0.1</b>	Hz
Timing:	<b>3</b>	Min
Test Voltage:	<b>30</b>	kV
Current Limit:	<b>19</b>	mA
Voltage Limit:	<b>34</b>	kV
<hr/>		
Selection	Change	Return

**Figure 5 (Limit setting interface)**

On limit setting interface as shown in figure 5, the user can set output frequency, test time and voltage, overcurrent protection value on high-voltage side and overvoltage protection value according to test requirement. The modification methods are as follows:

(A) Click “Selection” key, and the special selective box can be shifted among the parameters in cycle. The selected parameters can be modified through “data modification” key.

(B) Click “Change” key and the parameter selected by the special box can be modified in cycle according to incremental method.

- ★ There are three options for the frequency: 0.1, 0.05 and 0.02. It specified the output frequency of the instrument. The unit is Hz.
- ★ Timing modification scope: 0-99 mins. It specified the time of test. The unit is minute.
- ★ Range of test voltage is from zero to rating, unit is kV. It specified the test voltage to be boosted. When the voltage of the instrument reaches to this set value, it will stop boosting, maintain at this peak value and output uniform amplitude sine wave.
- ★ The setting scope of current protection value is from 0 to the rating, the unit is mA. It specified the upper limit of the current of the sample. If the current exceeds this set value, the instrument will automatically cut off the output and shut down.
- ★ The voltage protection value is from 0 to the rating, the unit is kV. It specified the upper limit of the voltage of the sample. In case the voltage exceeds the set value, the instrument will automatically cut off the output and shut down.

(C) Click “Return” key, the instrument will enter into voltage boost standby interface as shown in figure 6.

### **(3) Standby Interface**

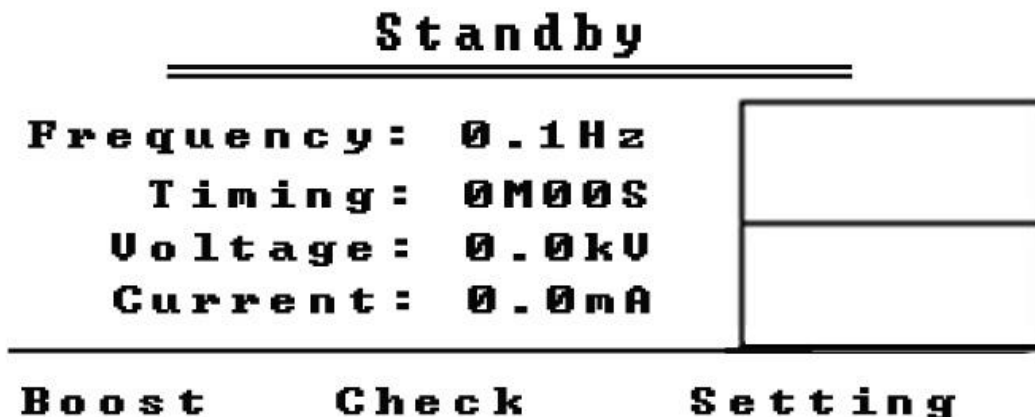

**Figure 6 (Standby Interface)**

The Standby Interface has three functions as follows:

- (A) Click “Boost” key, the instrument will enter into automatic boost procedure.
- (B) Click “Setting” key, the instrument will return to set limit sub-interface as shown in figure 5 to re-modify parameter.
- (C) Click “Check” key to check the test data in the last nine times.

**(4) Automatic Boost**

Click “Boost” key as shown in Figure 6, the instrument will enter into boost test under microcomputer control according to the procedures as follows:

Self check→boost→uniform amplitude output→shutdown

**Descriptions:**

**(A) Self check**

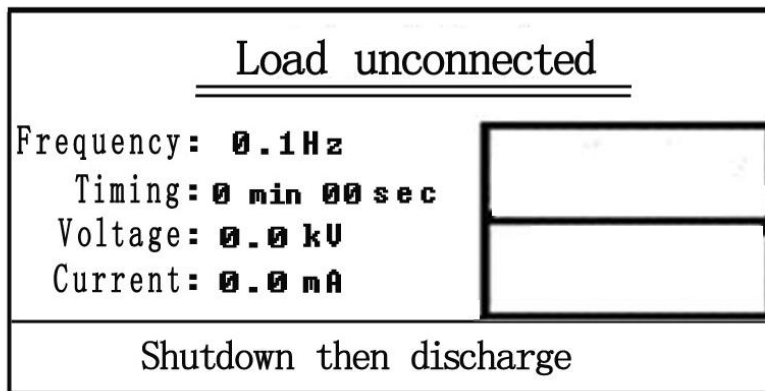

**Figure 7**

On self-check, the instrument outputs a detecting voltage to check the system. If the condition is normal, the instrument will boost. If the condition is abnormal, the instrument will shut-down, and the prompt message “load unconnected” will appear as shown in figure 7, in case the booster or the capacitor sampler is not connected or there is a failure with the instrument.

**(B) Boost**

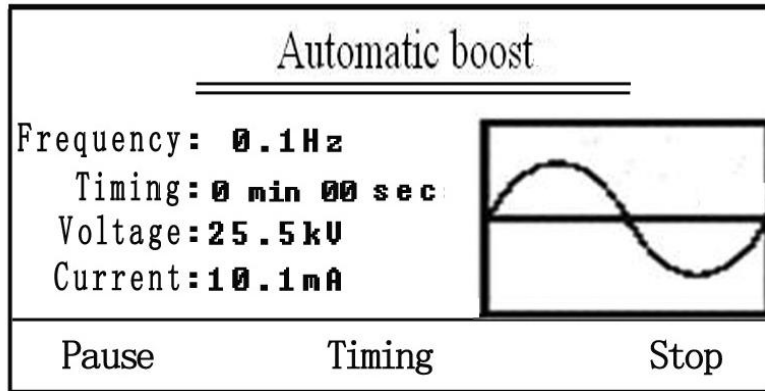

**Figure 8**

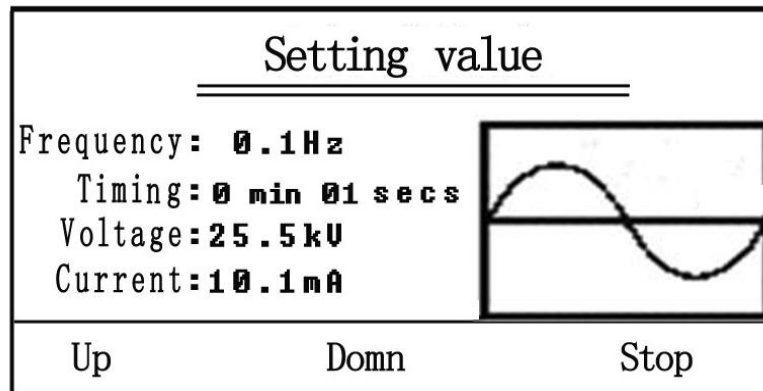

**Figure 9**

If the self-check has passed successfully, the instrument will automatically enter into boost status, as shown in Figure 8. It will take several cycles to increase the voltage to the set value for the instrument. During boost process, click “Pause” key as shown in Figure 8 can pause the boost process, and the instrument will have uniform amplitude output. At the same time, the key will be automatically turned into “boost” key, which can

be re-clicked to continue the boost process until the set voltage of the instrument is reached. The two functions are alternative. Click “Timing” key in boost process, the instrument will begin timing process, or you can wait until the voltage is increased to the set value, then the instrument will have automatic timing. At the same time the “timing” key will be turned into “Stop” key as shown in Figure 9.

**(C) Voltage fine adjustment**

In case the output voltage cannot satisfy the requirement, click “Up” or “Down” keys to adjust the voltage. After each click, an observation of at least one cycle shall be made, then make the adjustment until achieving satisfied condition.

**(5) Shut-down**

Two shut-down modes are available for this instrument

- ★ Timing shut-down: the instrument will shut down at specified set time.
- ★ Manual shut-down: click “Stop” key can stop the instrument.

These two shut-down methods are normal ones. After shut-down, the prompt interface “Test Passed” will appear as shown in Figure 10. In general, it will be considered that the instrument has passed the test, if there is no electrical discharge, overvoltage or overcurrent protection on the sample.

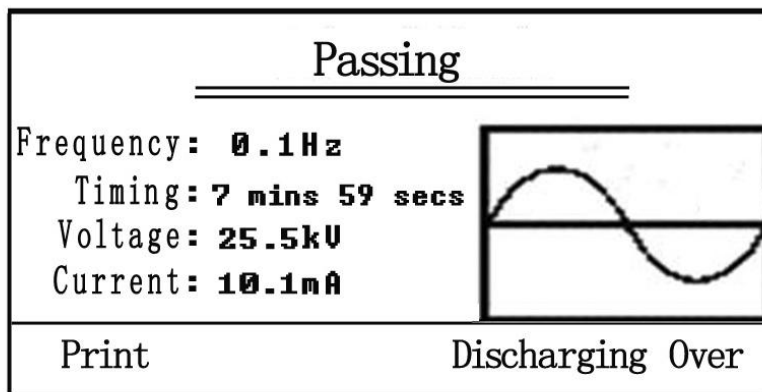

**Figure 10**

- ★ Additionally there are two abnormal shut-down: overvoltage and overcurrent protective shut-down functions. In case of shut-down, the prompt interface will appear as shown in Figure 12.

After start-up shut-down command, the instrument will automatically cut off the output,

then execute the historical data storage.

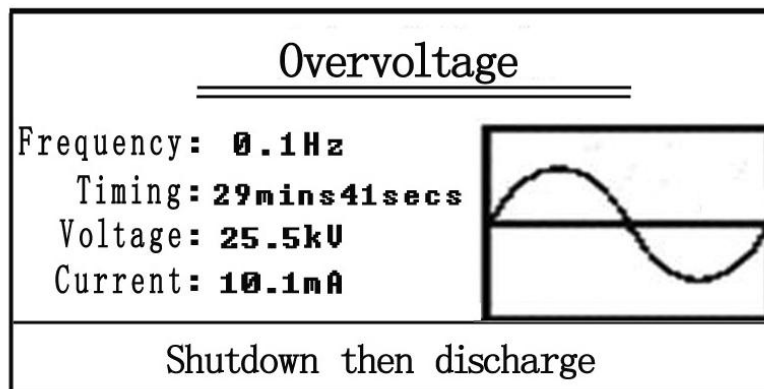

Figure 11

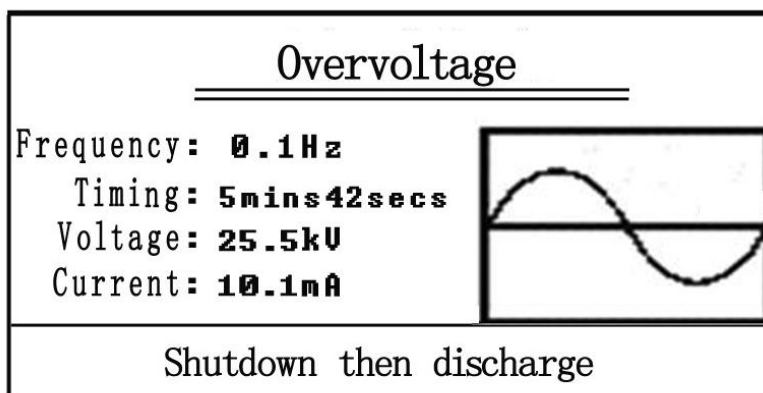

Figure 12

**(6) Print**

Click “Print” key according to tips as shown in Figure 10, the user can print the data shown on the display as test report. On historical data checking status, click “Print” key, the user can print out the historical data as shown on the screen.

**(7) Historical data check**

Data displayed on condition of timing shut-down, click key “Stop”, overvoltage and overcurrent protective shut-down will be stored by the instrument as historical data. Data of last nine times will be stored, and previous data will be automatically eliminated. Click the “Check” key as shown in Figure 6, the user can check the historical data of tests in the last nine times.

## VII. Accompanied Accessories

1. One special high-voltage connecting cable
2. One special low-voltage connecting cable
3. One power cable
4. Ten power supply fuse tubes
5. One discharging rod

## VIII. Packing List

No.	Item	Qty
1	Main engine	1
2	Booster	1
3	Power line	1
4	Ground lead	1
5	Print paper	2
6	Fuse pipe	2
7	Discharge bar	1
8	Compensation capacitor	1
9	High voltage connection cable	2
10	Dedicated low voltage connection cable	1